



108 LX/LXP (ALX, ALXP)

108 LX/LXP (ALX, ALXP) Operational Manual



108 LX Series VersaClimber

(LXP, ALX, ALXP)

ASSEMBLY AND OPERATIONAL MANUAL



1.800.237.2271 | 714.850.9716 | Fax: 714.755.5749 | www.versaclimber.com | email@heartrateinc.com

Heart Rate Inc. 3190-E Airport Loop, Costa Mesa, California 92626 The VersaClimber is manufactured in the USA by Heart Rate Inc.

© 2007 Heart Rate Inc. All Rights Reserved. Made in USA

ASSEMBLY AND OPERATION MANUAL

FOR ALL LX SERIES VERSACLIMBERS

TABLE OF CONTENTS

GENERAL INTRODUCTION.....	1
CALORIE BURN RATES	2
STEPPING USER GUIDE	3
CLIMBING USER GUIDE	4
MODULE DISPLAY	5
HEART RATE MONITORING	6 - 7
PROGRAM LEVEL CHART	8
DETAILED USER GUIDE	9 - 10
SELECTING STEP HEIGHT	11
SELECTING SPEED/TIME	12
USING VARIBALE CONTROL RESISTANCE	13
SEAT/PEDALING USER GUIDE	14
USER GUIDE FOR AEROBIC & POWER CONDITIONING.....	15 - 17
STANDARD VS. CROSS CRAWL PATTERN.....	18
INTERVAL SPRINT TRAINING	19 - 21
USING THE VERSACLIMBER WITH MINOR INJURIES.....	22 - 23
UNPACKING INSTRUCTIONS	24
ASSEMBLY INSTRUCTIONS - SINGLE MACHINE	25 - 29
ASSEMBLY INSTRUCTIONS - HI-TRI AND HIGH FIVE	30
MAINTENANCE SCHEDULE	31 - 34
TROUBLE SHOOTING GUIDE.....	35
VERSACLIMBER SPECIFICATIONS	36
SPARE PARTS LIST	37 - 38
WARRANTY.....	38 - 39

Baby Steps. Ease into your VersaClimber workout.

Members who use stepping machines for 1/2 hour or more in my club can only use the Versaclimber for a few minutes. Why is that?

LET'S TALK ABOUT IT!

Most stepping machines have a 12" to 14" maximum step height. The VersaClimber has a 20" maximum step height.

Most people that use stepping machines take a 5" to 8" step height, because taking longer steps on a stepping machine is **PHYSICALLY UNCOMFORTABLE**. These same people take a 15" to 20" step height on the VersaClimber, because it is **PHYSICALLY MORE COMFORTABLE**.

Most people lean on the hand rails of stepping machines and therefore, reduce their gravitational body stepping weight resulting in cheating and burning less calories. The same people cannot "cheat" on the VersaClimber because 100% of their body weight is climbing.

Members who use stepping machines at 1/2 to 1/3 the step height of a VersaClimber are exerting 1/2 to 2/3 less energy at the same step rate. If they take the same step height and step rate on the Versaclimber as they take on a stepping machine, they can exercise for the same length of time on either machine. Or, if they take a longer step on stepping machines than on the VersaClimber, they will be able to VersaClimb longer than they can step.

Most people exercise at a repetition rate of about 120 steps per minute because it is a common aerobic music dance beat, cycling and running frequency. Most people climb 120 steps per minute or faster on the Versaclimber. If you VersaClimb at the same rate that you step on stepping machines, but at **DOUBLE** or **TRIPLE** the step height, your workout intensity is **DOUBLED** or **TRIPLED** making it uncomfortable and more demanding.

SO WHAT'S THE ANSWER?

Begin the VersaClimber workout **with both feet at the same level**. People that can step for 1/2 hour or more can also climb for 1/2 hour or more, **IF THEY WORKOUT AT THE SAME INTENSITY**—achieved by simply reducing the step height on the VersaClimber.

DO YOUR MEMBERS A FAVOR!

Teach them to take a slow 5" to 8" step height, like they do on stepping machines. They will then be able to enjoy a long and satisfying total body exercise on the VersaClimber.

WARNING

BEFORE UNPACKING, ASSEMBLING, OR EXERCISING ON THE VERSACLIMBER, READ THIS OPERATION MANUAL THOROUGHLY. INSTRUCT OTHERS HOW TO USE THE MACHINE IN ACCORDANCE WITH THE PROCEDURES OUTLINED IN THIS MANUAL. ADDITIONAL MANUALS ARE AVAILABLE UPON REQUEST FROM HEART RATE, INC. BEFORE BEGINNING THIS OR ANY OTHER EXERCISE PROGRAM, CONSULT YOUR PHYSICIAN. THIS IS ESPECIALLY IMPORTANT FOR THOSE INDIVIDUALS OVER THE AGE OF 30 AND THOSE WHO HAVE KNOWN HEALTH PROBLEMS. HRI ASSUMES NO RESPONSIBILITY FOR PERSONAL INJURY OR PROPERTY DAMAGE SUSTAINED BY OR THROUGH THE USE OF THE VERSACLIMBER.

GENERAL INTRODUCTION

TOTAL BODY CLIMBING

The VersaClimber, introduced in 1981, was the first climbing exercise machine on the market. It utilized one of the most natural, complete and intensive activities to which the body can be subjected - continuous, total body, vertical climbing. This total body climbing exercise machine provides an alternating arm and leg action against gravity with variable stroke length and speed. All the major muscles of the arms, shoulders, back, chest, hips, buttocks and legs are used while climbing. The VersaClimber is a proven and widely accepted, injury free, total body exerciser that is used presently by health clubs, sports training facilities, rehabilitation clinics, all branches of the armed forces, and professional athletes.

VersaClimber combines, in one exercise machine, the aerobic conditioning found in activities such as: climbing, stepping, spinning, trail running, roller blading, cardio classes and cross country skiing. It also provides the isokinetic training effects of resistance training of a pull up, shoulder press, squat, lat pull down and military press. All of these activities are symmetrical, reciprocal and can be performed rhythmically and without orthopedic trauma. The upper and lower body major muscle contractions maximize peripheral blood flow, providing for higher levels of energy expenditure at lower levels of blood pressure and perceived exertion.

A microcomputer monitors and displays the performance of the pedaling, stepping and climbing activities. The heart rate monitor is used to guide the intensity of the workout using heart rate as the speedometer of exercise.

NOTE:

BEGIN WITH FEET LEVEL THEN TAKE SHORT 4-6 INCH STEPS TO BEGIN. FIRST TIME USERS OF THE VERSACLIMBER HAVE A TENDENCY TO CLIMB TOO FAST AND TO TAKE TOO LONG A STEP. UNTIL USERS BECOME THOROUGHLY FAMILIAR WITH THE VERSACLIMBER, IT IS MANDATORY THAT THEY TAKE SHORT, SLOW STEPS. "LIMIT STOPS" HAVE BEEN PROVIDED TO SET THE RANGE OF MOTION BASED ON THE ABILITY OF THE USER. FOR EXAMPLE, A MAXIMUM 6" STROKE LIMITATION MAY BE SET FOR BEGINNERS IN THE SEATED, STEPPING, OR CLIMBING POSITIONS.

TYPICAL CALORIE BURN RATES

Take a moment to review the following activity comparisons. Note the difference in calorie expenditures and speeds for various exercises. Full body climbing ranks highest in caloric expenditure over all other activities even though speed is the slowest. Users often try to maintain the speed that they are used to in other activities and over exert themselves due to the total body, arm and leg movement involved in climbing at 75 degree angle. Therefore, it is recommended that first time users of the VersaClimber begin with the feet level in the stepping positions at a slow comfortable pace and a 4-6 inch step height.

CALORIES

<u>ACTIVITY</u>	<u>SPEED</u>	<u>BURNED/MINUTE</u>
Walking	3.0 mph	3.8
Bicycling	9.4 mph	6.4
Swimming	2.0 mph	8.1
Running	7.5 mph	13.2
Stepping	1.9 mph	14.4
Climbing	1.5 mph	16.2

VERSACLIMBER CALORIES BURNED PER HOUR CHART

	40	50	60	70	80	90	100	110	120	130	140	150	160	170
	FEET PER MINUTE													
80	205	238	270	303	335	368	400	432	465	497	530	562	595	627
90	231	267	304	340	377	414	450	487	523	560	596	633	669	706
100	257	297	338	378	419	459	500	541	581	622	662	703	743	784
120	308	357	405	454	503	551	600	649	697	746	795	844	893	942
130	334	386	439	492	545	597	650	703	756	808	861	914	966	1019
140	359	416	473	530	586	643	700	757	814	870	927	984	1041	1098
150	385	446	507	567	628	689	750	811	872	933	994	1054	1115	1176
160	411	475	540	605	670	735	800	865	930	995	1060	1125	1190	1255
170	436	505	574	643	712	781	850	919	988	1057	1126	1195	1264	1333
180	462	535	608	681	754	827	900	973	1046	1119	1192	1265	1338	1411
190	487	565	642	719	796	873	950	1027	1104	1181	1258	1336	1413	1491
200	513	594	675	757	838	919	1000	1081	1162	1244	1325	1406	1487	1491
210	539	624	709	794	880	965	1050	1135	1221	1306	1391	1476	1562	1647
220	564	654	743	832	922	1011	1100	1189	1279	1368	1457	1546	1636	1725
230	590	683	777	870	963	1057	1150	1243	1337	1430	1523	1617	1710	1803
240	616	713	811	908	1005	1103	1200	1297	1395	1492	1590	1687	1785	1882

Weight
in lbs.

1. Find your weight in the weight column
2. Find your climbing speed in feet per minute at the top of the chart
3. Read calories burned per hour in table

STEPPING USER GUIDE

LEARN TO USE THE VERSACLIMBER AS A STEPPING MACHINE BEFORE USING IT AS A CLIMBING MACHINE.

The hand rails not only provide support while getting on and off the VersaClimber, but also the option of another exercise modality - Stair stepping.

1. Hold the stationary hand rails and step on the lower foot pedal. Then, step on higher foot pedal until feet are level and stop.
2. Switch on display.
3. Turn hydraulic control knob toward "step slower."
4. Hold hand rails and take short, slow 6 inch steps for about ten minutes.

Step onto machine by placing enough weight on the lowest pedal to bring it to its bottom position. Support the upper body by holding the hand rails.



Step up with the opposite leg and level feet.



DECREASE STEP RATE AND STEP HEIGHT FOR EASIER EXERCISE.

By holding the hand rails in the front or to the side of the body and stepping with the legs only, the gluts, hip flexors, quads, hamstrings, calves and shins can achieve a complete lower body aerobic and strength exercise. A variable stroke length of 1" to 20" is available. Unlike other stair stepping machines, the foot pedal velcro straps allow the user to perform leg lifts in the upward motion of the stroke to achieve a more effective and balanced lower body workout. By shifting the hands from the stationary hand rails to the moving hand grips, the machine automatically converts from a stepping machine into a total body climbing machine or back to a stepping machine simply by changing hand position.

NOTE:

TO MAINTAIN TRAUMA FREE MOTION, IT IS MANDATORY THAT YOU DO NOT, UNDER ANY CIRCUMSTANCES, "BOTTOM OUT" AT THE END OF EACH STROKE. ALSO, DO NOT HIT THE STEP HEIGHT LIMITERS WHEN THEY ARE IN USE.

CLIMBING USER GUIDE

1. Hold hand rails for support. Put foot on the lowest pedal. Apply enough weight to bring the pedal to its lowest position. Step up with the other foot onto the higher pedal until both feet are level.
2. With both feet at the same level, hand grips should be positioned at about shoulder height. Adjust handles if necessary by depressing the pin at the end of the hand grip. Remove it from its position and reinsert into hand grip adapter near shoulder height, and release the pin.

3. Press ON/OFF button to turn on.
In Standard Mode: "Time, Rate and Distance" information will be displayed.

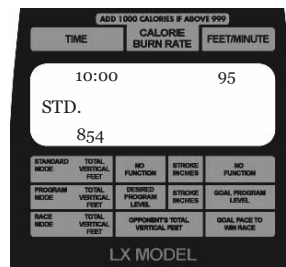

4. After both feet are level, begin climbing by taking a short stroke length of approximately 4" - 6" for approximately 10 minutes. "Stroke Rate" and length are determined by the activity of the person climbing. After three twenty minute workouts, the step height can be increased gradually from 4" - 6" up to a maximum of 20."

IDEAL STEP
4-6" Step Height
is the ideal step
range for those
starting out.

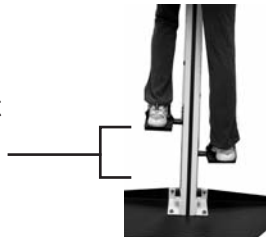

WARNING

WHEN GRASPING THE HAND RAILS OR HAND GRIPS, KEEP FINGERS AND THUMBS ON THE FOAM PADDING OF THE HAND RAILS OR RUBBER GRIPS OF THE HANDLES. DO NOT GRASP OR EXTEND ANY PORTION OF THE HAND BEYOND THE FLANGES OF THE MOVING HAND GRIPS. DO NOT HOLD ONTO THE VERTICAL POST.

MODULE DISPLAY

Selecting 3 modes of operation.

STANDARD MODE

1. Step on the lower pedal first. Then step on the higher pedal until both feet are even.
2. Adjust handles at approximately shoulder height. Press the button at end of handle to reposition.

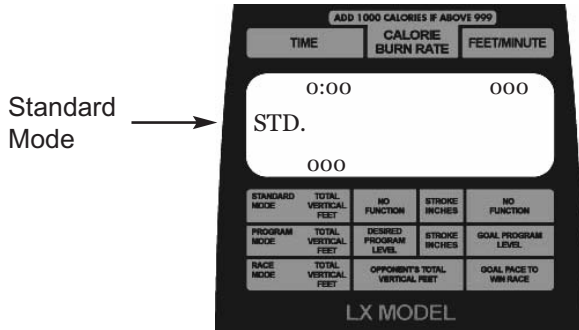

3. Press "ON/OFF" and the computer defaults to the standard mode. (STD)
4. Press "ON/OFF" when finished. The display will turn off after two minutes of inactivity.

PROGRAM MODE

1. Press "ON/OFF" and press "PROGRAM MODE"
2. The display will ask you to "ENTER TIME". Keypad in a desired exercise time and press "ENTER".

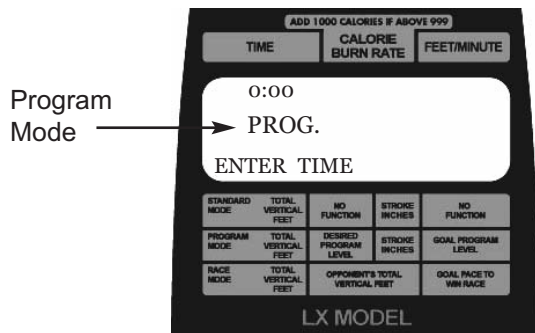

3. The display will ask you to enter a program from 1 through 15. Keypad in a desired program number and press "ENTER".
4. Press "START EXERCISE" and begin your program.

5. The object is to match your ACTUAL FEET PER MINUTE displayed in the upper right hand corner of the display with the GOAL FEET PER MINUTE located directly below.
6. You can exit the program at any time by pressing "RESET".
7. Press "ON/OFF" when finished. The display will turn off after 2 minutes of inactivity.

RACE MODE

1. Press the "RACE MODE" button.
2. The display will ask you to enter exercise time. Keypad in total minutes and press "ENTER".
3. The display will then say enter Total Feet you wish to climb. Keypad in desired feet from 0 to 9999 and press "ENTER". Press "START EXERCISE" and begin your program.

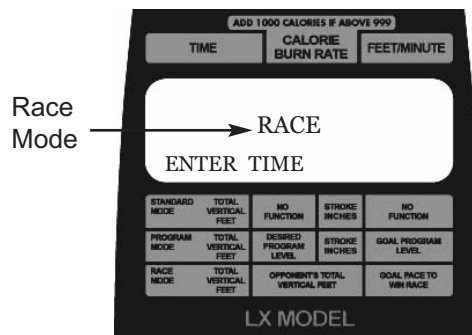

5. The object is to exceed your OPPONENTS FEET PER MINUTE displayed in the lower right hand corner of the display.
6. You can exit the program by pressing "RESET".
7. Press "ON/OFF" when finished. The display will turn off after 2 minutes of inactivity.

HEART RATE MONITORING USER GUIDE FOR HEART RATE MODELS



The Heart Rate Monitoring mode is intended to guide the exerciser through an aerobic exercise based on their heart rate. It is recommended to select and start with the minimum 70% of maximum age-related heart rate as suggested in this manual.

To use the Heart Rate Monitoring mode, you must wear a chest strap transmitter shown below. The strap should be snug enough to hold electrodes securely against the skin to prevent motion of the electrodes but should not feel uncomfortable.

HOW TO FIND YOUR TARGET HEART RATE

Heart rate is the best indicator of exercise intensity. Use your heart rate and level of perceived exertion (how you feel) as a guide to determine if you have selected the proper "LEVEL OF CONDITIONING". The following HEART RATE TRAINING ZONE CHART may be used to assist you in selecting your appropriate heart rate training zone.

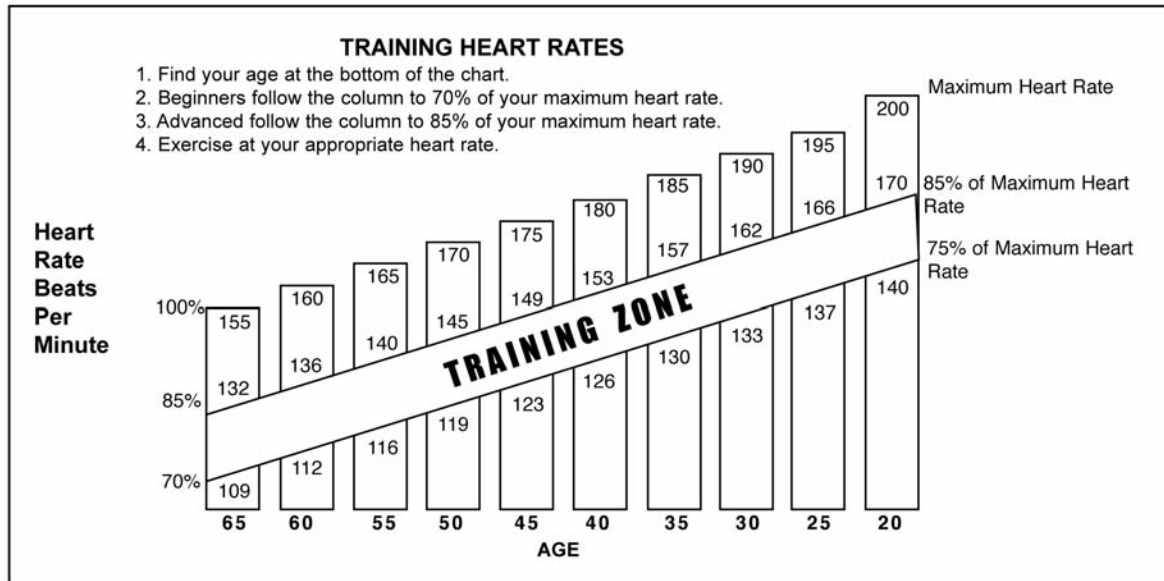

HEART RATE TRAINING GUIDE

1. Find your age at the bottom of the chart.
2. Beginners follow the column to 70% of your maximum heart rate.
3. Advanced follow the column to 85% of your maximum heart rate.
4. Exercise at your appropriate heart rate.

HEART RATE MODE (for LXP or ALXP models only)

Read Heart Rate Mode

Place Adjustable Chest Strap Here.



1. Place the Heart Rate Polar compatible transmitter strap on the chest just below the breast pectoral muscles. Moisten the skin.

- The strap can be moved up or down and left to right to find the best transmission area on the chest.
- On the module, press "ON/OFF" and then press "READ HEART RATE".

NOTE: Heart Rate can be read in each of the 4 modes by simply pushing the "READ HEART RATE" button at any time.

- Press "ENTER PERSONAL INFO".
- Enter your age on number keypad and press "ENTER".
- Calculated heart rate max will be displayed.

NOTE: To change HR max number press "0" three times and then key in a heart rate goal.

- Press "ENTER".
- Press "START EXERCISE".

TIME	HEART RATE	FEET/MINUTE		
2:87	87	65		
109	185	6		
32				
STANDARD MODE	TOTAL VERTICAL FEET	MAX HEART RATE	STROKE INCHES	% MAX HEART RATE
HEART RATE CONTROL MODE	TOTAL VERTICAL FEET	DESIRED HEART RATE	STROKE INCHES	GOAL HEART RATE
PROGRAM MODE	TOTAL VERTICAL FEET	DESIRED PROGRAM LEVEL	STROKE INCHES	GOAL PROGRAM LEVEL
RACE MODE	TOTAL VERTICAL FEET	OPPONENTS TOTAL VERTICAL FEET		GOAL PACE TO WIN RACE

Calculated Max Heart Rate based on your age

This number is the % of your Max heart rate. As your HR increases so does the %. Ideal training based on 60-80% of your HR Max

- As you begin to workout, the % Max Heart Rate number will increase as your heart rate rises. It is recommended to maintain a range of 60-80% of Heart Rate Max. The module will beep to notify you when your heart rate max has been exceeded.

Heart Rate Control Mode

With Polar compatible chest strap in place, Press "CHANGES MODES" button and select "HRC"

- Press "ENTER PERSONEL INFO".
- Enter age on number keypad and press "ENTER".
- Your Calculated heart rate max will be displayed.
- Press "ENTER" for 80% of max heart rate or change by pressing 0 three times and then key in a heart rate goal.

NOTE: The new Heart Rate goal (number) you input will always default to an output of 80%

- Enter in amount of time. Press "ENTER".
- Press "START EXERCISE".
- Begin climbing. Match "Actual Feet Per Minute" to "Goal Feet Per Minute" indicated by up and down arrows. The computer will display the proper climb rate to keep user in the desired target heart rate range.
- Match the goal speed that is updated every 30 seconds.

Heart Rate Control Mode

TIME	HEART RATE	FEET/MINUTE		
2:87	87	50		
HRC	148	6		
		51		
STANDARD MODE	TOTAL VERTICAL FEET	MAX HEART RATE	STROKE INCHES	% MAX HEART RATE
HEART RATE CONTROL MODE	TOTAL VERTICAL FEET	DESIRED HEART RATE	STROKE INCHES	GOAL HEART RATE
PROGRAM MODE	TOTAL VERTICAL FEET	DESIRED PROGRAM LEVEL	STROKE INCHES	GOAL PROGRAM LEVEL
RACE MODE	TOTAL VERTICAL FEET	OPPONENTS TOTAL VERTICAL FEET		GOAL PACE TO WIN RACE

Your feet per minute.

Match this number by climbing faster or slower. This number is determined by heart rate.

WARNING:

YOUR HEART RATE SHOULD BE USED AS A GENERAL REFERENCE FOR THE INTENSITY LEVEL OF AN EXERCISE ACTIVITY. CONSULT A PHYSICIAN BEFORE BEGINNING THIS OR ANY OTHER EXERCISE. IMMEDIATELY DISCONTINUE THIS OR ANY OTHER EXERCISE IF YOU FEEL FAINT, ANY DISCOMFORT, SHORTNESS OF BREATH, OR DIZZINESS.

PROGRAMMED LEVEL CHART

		PROGRAM NUMBERS															
		1	2	3	4	5	6	7	8	9	10	11	12	13	14	15	16
		FEET PER MINUTE CLIMB RATES															
Minutes		10	15	20	25	30	35	40	45	55	75	95	115	135	155	175	195
0-1		10	15	20	25	30	35	40	45	55	75	95	115	135	155	175	195
1-2		15	20	25	30	35	40	45	50	60	80	100	120	140	160	180	200
2-3		20	25	30	35	40	45	50	55	70	90	110	130	150	170	190	210
3-4		25	30	35	40	45	50	55	60	80	100	120	140	160	180	200	220
4-5		30	35	40	45	50	55	60	65	85	105	125	145	165	185	205	225
5-6		25	30	35	40	45	50	55	60	80	100	120	140	160	180	200	220
6-7		30	35	40	45	50	55	60	65	90	110	130	150	170	190	210	230
7-8		35	40	45	50	55	60	65	70	100	120	140	160	180	200	220	240
8-9		25	30	35	40	45	50	55	60	85	105	125	145	165	185	205	225
9-10		30	35	40	45	50	55	60	65	90	110	130	150	170	190	210	230
10-11		35	40	45	50	55	60	65	70	100	120	140	160	180	200	220	240
11-12		40	45	50	55	60	65	70	75	110	130	150	170	190	210	230	250
12-13		30	35	40	45	50	55	60	65	105	125	145	165	185	205	225	245
13-14		35	40	45	50	55	60	65	70	110	130	150	170	190	210	230	250
14-15		45	50	55	60	65	70	75	80	100	120	140	160	180	200	220	240
15-16		30	35	40	45	50	55	60	65	90	110	130	150	170	190	210	230
16-17		35	40	45	50	55	60	65	70	100	120	140	160	180	200	220	240
17-18		40	45	50	55	60	65	70	75	110	130	150	170	190	210	230	250
18-19		35	40	45	50	55	60	65	70	100	120	140	160	180	200	220	240
19-20		30	35	40	45	50	55	60	65	105	125	145	165	185	205	225	245
20-21		35	40	45	50	55	60	65	70	100	120	140	160	180	200	220	240
21-22		40	45	50	55	60	65	70	75	110	130	150	170	190	210	230	250
22-23		30	35	40	45	50	55	60	65	105	125	145	165	185	205	225	245
23-24		35	40	45	50	55	60	65	70	110	130	150	170	190	210	230	250
24-25		45	50	55	60	65	70	75	80	100	120	140	160	180	200	220	240
25-26		30	35	40	45	50	55	60	65	90	110	130	150	170	190	210	230
26-27		35	40	45	50	55	60	65	70	100	120	140	160	180	200	220	240
27-28		40	45	50	55	60	65	70	75	110	130	150	170	190	210	230	250
28-29		35	40	45	50	55	60	65	70	100	120	140	160	180	200	220	240
29-30		30	35	40	45	50	55	60	65	105	125	145	165	185	205	225	245
30-31		35	40	45	50	55	60	65	70	100	120	140	160	180	200	220	240

Beginner				Average				Advanced				Elite			
FEET				FEET				FEET				FEET			
32	37	42	47	52	57	62	67	95	115	135	155	175	195	215	235
AVERAGE FEET PER MINUTE				AVERAGE FEET PER MINUTE				AVERAGE FEET PER MINUTE				AVERAGE FEET PER MINUTE			

There are four major Program workout levels. Beginner 1-4, Average 5-7, Advanced 8-11 and Elite 12-16. Select a Program level when prompted by the display module based on your level of fitness. Increase or decrease the level to fit your needs. All Programs have built in warm up and warm down. The warm up is shown on the chart but the warm down is not shown.

Select an exercise time when prompted by the display module. When you select an exercise time, remember that the program includes a 5 minute warm down (not shown on the chart). For example if you choose Program Level 5 and a 10 minute workout time you will climb for 1 minute at 30, 35, 40, 45, and 50 feet per minute and for 5 more minutes at a decreasing speed for a total of 10 minutes. If you choose to workout without the warm down included, add an extra 5 minutes to the time entered.

DETAILED USERS GUIDE

1. STEPPING ON - Hold the hand rails for support. Put the foot on the lowest pedal (photo 1) Apply enough weight to bring the pedal to its lowest position. Step up with the other foot (photo 2) onto the higher pedal stepping up until both feet are level (photo 3) This is the starting position.



Photo 1



Photo 2



Photo 3

2. HANDLE SELECTION - The VersaClimber is supplied with one pair of straight quick release handles. To adjust the handles, simply depress the pin at the end of each handle and remove it from its position. Reinsert the handle into the adaptor closest to the shoulder height of user and release the pin.



3. Begin climbing, taking a short 2 to 4 inch step as shown below.



WHEN GRASPING THE HAND RAILS OR HAND GRIPS, KEEP FINGERS AND THUMBS ON THE FOAM PADDING OF THE HAND RAILS OR RUBBER GRIPS OF THE HANDLES. DO NOT GRASP OR EXTEND ANY PORTION OF THE HAND BEYOND THE FLANGES OF THE HAND GRIPS. DO NOT HOLD ONTO THE MAIN VERTICAL POST.

4. CLIMB RATE & STROKE LENGTH - Climb rate and stroke length are determined strictly by the activity of the user. The user may take a stroke as short as 2 or 3 inches or as long as the machines movement allows. To maintain a shock and trauma-free motion, do not bottom out at the end of each stroke. The stroke rate can be maintained at a steady pace by using the beat of music and/or maintaining a specific stroke length, steps or feet per minute as indicated on the computer.

TO MAINTAIN A SHOCK AND TRAUMA FREE MOTION IT IS MANDATORY THAT YOU DO NOT, UNDER ANY CIRCUMSTANCES, "BOTTOM OUT" AT THE END OF EACH STROKE. ALSO, DO NOT HIT THE STEP HEIGHT LIMITERS WHEN THEY ARE IN USE.

5. HYDRAULIC CONTROL-



The rate of motion or climbing speed can be controlled hydraulically. The user, therefore, can simultaneously exert upward and downward forces by pushing and pulling with arms and legs against selected rates of motion. This results in more agonist and antagonist gross muscle mass contraction than on any other exercise machine. Faster step rates are selected for aerobic exercise and slower step rates are selected for low level aerobic and isokinetic muscle strength, power and endurance training.

Select rate of motion, (faster/slower) by rotating hydraulic control knob, when rate of motion is selected, any forces applied by the person (pedaling, stepping or climbing), will be resisted by the hydraulics set at that rate. Upper body or

lower body exercises can be performed fast or slow depending on the rate of motion selected with the hydraulics.

Perform aerobic exercises with the hydraulics set to a minimum. To set hydraulics to a minimum (increase rate of motion), turn the hydraulic control knob fully counter clockwise. To slow the rate of motion, turn the hydraulic control knob in a clockwise rotation. The rate of motion may be changed without stopping any time during exercise.

6. MODULE DISPLAY SYSTEM - The LX model VersaClimber has three modes of operation. Standard, Program and Race.

SELECTING STEP HEIGHT

**START SLOW AND TAKE SHORT STEPS!
USE THE VERSACLIMBER AS A STEPPER FIRST.**



No matter what level of conditioning you are at, start slow and take a 4" to 6" step height. Only take a step or stroke length that feels comfortable. Do not take long steps or you will tire quickly!

Although a step height of up to 20 inches is available, it is not necessary to take the maximum stroke length to receive cardiovascular and strength benefits.

RANGE OF MOTION (Optional Upgrade)

To ensure that users maintain a short stroke length, range of motion limiters have been provided for each machine. These "stops" can be set in the pedaling, stepping or climbing positions and are designed for safe, controlled workout routines. They are easily installed and adjustable to 6 different range limitations.



**Limiter Bolt
(Optional Upgrade)**
Limits step range of motion.

The range of motion "limiters" or "stops", are located on the slide bar inside the track just above each left and right pedal. Extra holes have been threaded into the slide bar to allow the limiters to be adjusted up or down in 2 inch increments.

To decrease the range of motion, remove both limiters from their lowest position. Level pedals and re-install the limiters to a higher position (e.g. three holes down). Both left and right limiters should be in the same position on both sides.

Hold the stationary hand rails to the front or side of the body and begin stepping. Notice the limiters restrict the step height. Take short steps up to the stroke length the limiters will allow. Do not bottom out or hit the limiters against the frame. Do not over exert yourself. Step rate should be easy enough so that a minimum exercise of 10 minutes can be achieved.

SELECTING SPEED

Climbing uses many more muscles than jogging, pedaling or stepping and is therefore performed at a much lower cyclic rate. The "Feet Per Minute" rate indication is the most meaningful guide for the amount of work being done.

To determine speed or rate at which you are stepping, put the toggle switch in the up position to display "Feet Per Minute." A reasonable rate for a 25 to 35 year old person in good condition would be about 60 feet per minute. After 3 to 5 minutes of exercise, pulse rate should be checked and the climbing rate adjusted appropriately to bring the user to their target heart rate zone. Climbing at about 50 feet per minute would provide the equivalent work load of running a 10 minute mile, while 80 feet per minute would be closer to an 8 minute mile. Similarly, exercise level 7 on a stationary bike is roughly equivalent to 70 feet per minute on the VersaClimber. Exercise level 10 is roughly equivalent to 100 feet per minute on the VersaClimber set at minimum resistance.

If your weight exceeds 240 pounds, divide your weight in half and follow the above 3 steps. Double the calories per hour figure to get your total calorie burn rate based on your climbing speed (feet per minute) and weight.

For most people losing weight it is often very difficult. It requires discipline in your eating habits as well as participating in a regular exercise program. The objective to losing weight is to consume less and exercise more, thereby expending calories that would normally be stored in the body as fat. For example, 3,500 calories equals 1 pound of fat. If you eat 3,500 calories in a single day and expend 1,750 calories as energy (including walking, exercising, breathing etc.) you would gain a 1/2 pound of fat. Over a one week period, by consuming 3,500 calories each day and converting only half the calories into energy, you would gain 3 1/2 pounds. Remember, to lose weight you need to decrease your calorie intake and increase your physical activity. Elite athletes often eat thousands of calories each day to maintain their body weight due to their high and frequent exercise activity.

SELECTING EXERCISE TIME

A warm up period of at least 5 to 10 minutes should always be included in each VersaClimber workout. The first time user can climb for 15 minutes by including a 5 minute warm up and a 3 to 5 minute warm down period. Taking a short step at a slow climbing speed during the warm up period is the key to a great workout. With repetitive use, it is possible to build up to longer exercise times and higher rates.

Many individuals enjoy 60 or more minutes of uninterrupted climbing. At the end of climbing, note your time and distance readings for establishing a goal for future sessions. Always use pulse rate and perceived exertion to determine if you are at a comfortable exercise level. Remember that work intensity is based on climbing speed. Climb at a faster or slower "Feet Per Minute" speed to increase or decrease your work intensity.

USING HYDRAULICS TO SELECT THE RATE OF MOTION

Beginners and individuals who are deconditioned may use the hydraulics to control the rate of motion or speed of the exercise. The hydraulic control knob is located at the bottom of the control console. Clockwise rotation of the control knob, (to the right), slows the rate of motion. Counter-clockwise rotation of the control knob, (to the left), increases the rate of motion. The rate of motion, (slower/faster), may be changed without stopping any time during exercise. Start with the speed control knob fully rotated clockwise and gradually increase the climb rate to the desired speed by turning the control knob in the counter-clockwise direction.

NOTE:

ALX models are fixed resistance and do not feature a variable tension control knob.



To use the hydraulic control as a low level exercise, turn the hydraulic control knob fully in the clockwise direction. Transfer weight from one foot to the other to cause the machine to move at the slow preset rate. Then, gradually turn the knob to climb at the desired speed. Do not try to push or pull the foot pedals or hand grips to cause the machine to move faster than it does by weight transference. Once again, take strokes that are comfortable. Common rates in this mode are between 20 and 30 feet per minute.

STAIR STEPPING

The VersaClimber provides the ability to perform variable height and variable speed stair stepping exercises for the lower body only. The hand rails, located about waist high, are used to grasp and thus stabilize the upper body while stepping with the legs only. The upper body is maintained in an erect stationary position while the legs and hips perform a lower body stepping exercise. The foot straps also allow the user to perform a leg lift exercise while stepping, not available on single purpose stepping machines.

By holding the hand rails in front of you or to the side of your body and stepping with legs only, the buttocks, front and back of the thighs, calves, and shins can achieve a complete lower body aerobic and strength workout. Stair stepping is recommended for beginners before they attempt a full body climbing exercise and can be performed in any mode of operation. Heart rate can be increased or decreased while stepping by increasing or decreasing step rate and stroke length.

Set the rate of motion desired with the hydraulic control knob. To perform a leg lift exercise, use the stirrups and lift with one leg while stepping down with the other leg and alternate.

SEAT/PEDALING USER GUIDE

The seat option provides both a seated legs only exercise and a seated arm and leg exercise. Unlike bicycles, the stroke length is variable from 1" to 20", and the feet can push and pull for a complete leg exercise. By grasping the moving hand grips, the arms, chest and back muscles can be added to the leg muscle activity. The seated exercise is primarily for a warm up and low to medium exercise level.



THE SEAT OPTION PROVIDES THREE ADDITIONAL EXERCISES.

1. Pedal With Legs. Pedal with the legs only in the seated position while holding the stationary hand rails for upper body support.
2. Push And Pull With Arms. Grasp the moving hand grips and push and pull with arms only, allowing the legs to move passively.
3. Exercise Arms And Legs. Pedal with the legs while pushing and pulling with the arms.

The seat transforms the machine into a pedaler, plus a pedaler with upper body exercise. To accommodate differences in limb lengths, it may be necessary to lower the hand grips and adjust the seat horizontally and vertically. Beginners can perform a legs-only exercise comfortably by pushing and pulling with the feet. While bicycles have fixed range of motion, stroke length on the VersaClimber is controlled by the user from 1" to 20" through a complete range of pedaling rates. By grasping the moving hand grips, the muscles of the arms, shoulders, chest and back are added to the leg muscle activity. The seated exercise is for warming up and low to medium level exercises.

SEAT ADJUSTMENT

The seat assembly easily attaches to the VersaClimber by **fully inserting a pin through two holes in the mainframe of the VersaClimber and one of the holes in the seat assembly.** This comfortable bicycle seat is adjustable vertically with the pin and horizontally with a knob located under the seat. The vertical seat adjustment is for differences in leg lengths while the horizontal adjustment accounts for differences in arm lengths.

NOTE:

THE SEAT ASSEMBLY WEIGHS 8 POUNDS. IF YOU ARE UNABLE TO SUPPORT THE WEIGHT OF THE SEAT FIRMLY IN ONE HAND, DO NOT ATTEMPT VERTICAL ADJUSTMENT OF THE SEAT WITHOUT ASSISTANCE. DO NOT ATTEMPT SEAT ADJUSTMENT WHILE STANDING ON FOOT PEDALS OR WHILE SEATED.

USER GUIDE FOR AEROBIC CONDITIONING

NOTE:

REGARDLESS OF YOUR FITNESS LEVEL, THERE IS A STEP HEIGHT AND CLIMBING SPEED THAT CAN BE MAINTAINED FOR A MINIMUM OF 15 MINUTES.

The VersaClimber has the capability of providing an aerobic exercise which is superior to other types of aerobic exercise. Like swimming or cross country skiing, climbing involves both arms and both legs.

The following guidelines are provided to acquaint the first time user to aerobic exercise on the climber.

IF YOU CLIMB A MOUNTAIN "TOO FAST" YOU CAN ONLY CLIMB FOR A FEW MINUTES—TAKE YOUR TIME.

*All calculations are based on hydraulics set at minimum.

LEVEL OF CONDITIONING (Estimated)	CLIMB RATE (feet/min)	EXERCISE TIME (min)	DISTANCE CLIMBED (feet)	STEP HGHT (inches)
1. OUT OF SHAPE BEGINNER	20	3 - 10	60 - 200	3 - 5
2. BEGINNER	25	4 - 15	100 - 375	4 - 6
3. NOVICE	35	5 - 20	175 - 700	4 - 7
4. WEEKEND ATHLETE	50	7 - 20	350 - 1000	5 - 8
5. FAIR CONDITION	60	8 - 20	480 - 1200	5 - 9
6. GOOD CONDITION	80	10 - 20	800 - 1600	6 - 10
7. VERY GOOD CONDITION	100	12 - 20	1200 - 2000	7 - 12
8. EXCELLENT CONDITION	115	14 - 20	1610 - 2300	8 - 16
9. ELITE CLIMBER	125	16 - 20	2000 - 2500	8 - 18
10. KING OF THE MOUNTAIN	145	18 - 20	2610 - 2900	8 - 18

To use the chart, first select the "LEVEL OF CONDITIONING" that best describes you. Suppose the level you have selected was the (WEEKEND ATHLETE). Use the data shown in line (4) for the (WEEKEND ATHLETE). For your first workout on the VersaClimber, choose the lowest number in each section of the chart at your estimated "LEVEL OF CONDITIONING".

STRENGTH TRAINING

The VersaClimber can be used to develop strength, power and endurance for all of the major muscles of the body. The VersaClimber hydraulic control system provides an ISOKINETIC exercise. ISO: equal; similar. KINETIC: of or provided by motion. The term ISOKINETICS when applied to EXERCISE indicates that THE EXERCISE IS PERFORMED AT THE SAME RATE OF MOTION REGARDLESS OF THE AMOUNT OF FORCE EXERTED. More simply, when the rate of motion is selected, any forces applied by the person pedaling, stepping or climbing, high or low, will be resisted by the hydraulics, at that same pre-selected rate or speed.

STRENGTH

To develop full body strength, set the hydraulics to a slow rate of motion. Rotate control knob to the right (clockwise) until the desired slow rate of motion is obtained and perform 8 to 12 slow repetitions, Push and pull with both arms and legs in the upward and downward directions.

POWER

To develop power, set the hydraulics to a faster rate of motion. Rotate control knob to the left (counterclockwise) until the desired speed is obtained and perform 15 to 30 fast repetitions. Push and pull with both arms and legs in the upward and downward directions.

ENDURANCE

To develop endurance, set the hydraulics at intermediate rates of motion and pedal step or climb for extended periods of time, (30 minutes or more).

TYPES OF RESISTANCE EXERCISES

With the hydraulic control properly adjusted, the VersaClimber has the capability of providing various strength conditioning exercises. A lat pull, chin up, military/shoulder press, squat, leg press, and leg lift can all be implemented.

UPPER BODY EXERCISE

The arms, shoulders, chest and back can be isolated by standing on the base plate in front of the VersaClimber and pushing and pulling the moving handles. Position the handles so that they are within reach when the arms are fully extended. Select the desired rate of motion with the hydraulic control knob. With your hands in the start position (palms facing away from you), concentrate on pulling down right then left with your latissimus dorsi (side of back), posterior fibers of deltoids, (back of shoulders) and the triceps brachii (back of arm). This flexion on one side of the body with extension of the other side of the body will tone and trim your sides, stomach, back and back of arms.

To isolate more chest, (pectoralis group), biceps brachii (front of arms), anterior deltoids (front of shoulders) and stomach (abdominals) perform the same pulling action with a reverse grip (palms facing you). Both sets of muscle groups, front and back, can be worked by simultaneously pushing and pulling right and left. During this upper body only activity, a full range of cyclic rates and stroke lengths can be selected.

LEG LIFTS AND QUAD, HAMSTRING AND GLUTE SUPER SETS

For isolated leg lifts and leg presses, adjust the velcro foot straps to fit snug on the feet. Set the rate of motion with the hydraulic control knob. Grasp the hand rails to anchor the upper body. Maintain the foot in horizontal position while lifting against the foot straps. Perform the desired activity then recover as you would between intervals. See Interval Training, Page

For the advanced athlete, a "quad burn" can be achieved by squatting down (while holding the stationary hand rails) and performing a stepping exercise. Use the foot straps to secure the feet on the pedals and bend the knees until the thighs are approximately horizontal and the knees straddle the machine. Start with short steps, pushing down with one leg while lifting up with the other. Maintain the body weight within the base of the machine. Step in the squat position until quads "burn out" or quad fatigue occurs. This exercise can also be performed as an interval workout set.

Quad burn. Squat down, straddle knees until thighs are horizontal. Push and pull with legs while maintaining crouched position.



Foot Positioning

The position of the foot or feet on the pedals will allow the focus of the work to be in a concentrated area of the muscle or muscles. If tingling or numbness occurs, reposition the foot on the pedal (forward or back) until you are comfortable.

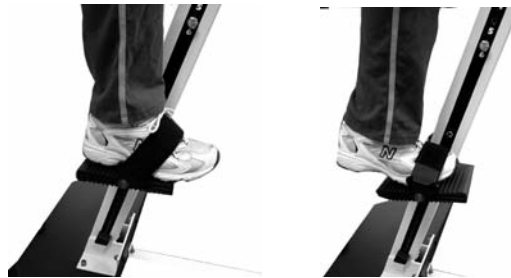

To concentrate the work on your ankle and calves. Climb on your toes. Quad work can be accentuated by climbing with the heel of the foot forward on the pedal. The intensity of the work for the inner legs can be increased by pointing the toes inward. Turning the toes outward will work the outer legs.

CROSS BODY, SAME SIDE, AND FULL BODY SETS CLIMBING VS. RUNNING MOTION

All Institutional VersaClimber Models, with the exception of models designated with "CC" for cross crawl or running motion, and the Clinical Model CL-108C have been designed with the standard "climbing motion". A "climbing motion" is produced, as the hand and foot on the same side of the body move in an upward direction, while the opposite arm and leg move in the downward direction.

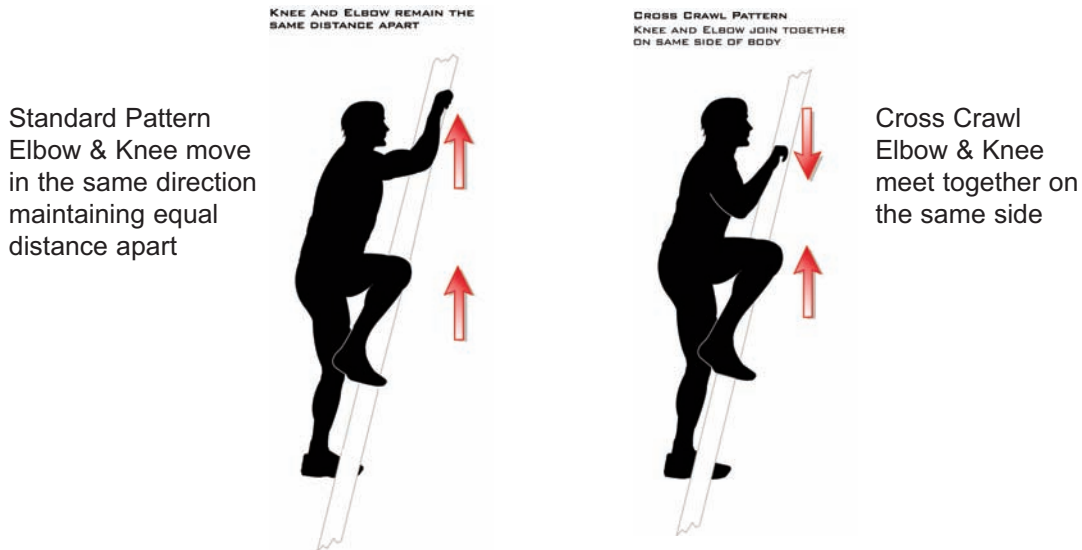

The "cross-crawl" or "running motion" provide a unique alternative to the standard "climbing motion". A "running motion" is produced as the arm and leg approach each other on one side of body while the opposite arm and leg separate on the other side.

CROSS BODY AND SAME SIDE STRENGTH SETS

CLIMBING MOTION

To perform "cross body" strength sets, adjust the hydraulics to the appropriate speed and tighten the foot straps. Climb using cross body forces by pulling down with the arm on one side of the body and lifting with the leg on the other side of the body. Move as though you were going to touch the elbow of the right arm to the opposite knee of the left leg as they come together. Then alternate.

To perform an alternate cross body strength set, push up with the left arm and down with the right leg. Alternate by pushing up with the right arm and down with the left leg.

RUNNING MOTION

To perform "same side" strength sets, adjust the hydraulics to the appropriate speed and tighten the foot straps. Climb using the forces on the same side of the body by pulling down with the arm and lifting up with the leg. Move as though you were going to touch the elbow of right arm to the right knee on the same side of the body. The left arm and knee on the opposite side of the body will separate. Alternate this pulling motion.

To perform an alternate "same side" body strength set, concentrate on pushing up with the right arm and down with the right leg on the same side of the body. Move as though you are

trying to push the elbow and the knee away from each other on the same side of the body. The left arm and leg on the opposite side of the body will come together. Alternate this pushing motion.

FULL BODY SETS

CLIMBING and RUNNING MOTIONS To perform full body strength sets, adjust the hydraulics to the desired speed and secure the foot straps. Exert upward and downward forces with the arms and simultaneously exert upward and downward forces with the legs. This activity is equivalent to a lat pull and military press for the upper body and a leg press and weighted lift for the lower body.

INTERVAL TRAINING

Interval training on the VersaClimber is for advanced level workouts. User's should be thoroughly familiar with all functions of the VersaClimber and be able to comfortably climb a minimum of 30 minutes per workout session before attempting this method of conditioning.

Interval training is for the advanced person who wants to increase their aerobic and anaerobic capacity. The purpose of interval training is to increase the intensity of the workload for a short period of time so that the oxygen supplied to the muscles is less than the amount of oxygen required to maintain the workload. An oxygen debt is created in the muscles and therefore they must work anaerobically or without oxygen for a short period of time. The intense portion of the interval is then followed by a short, low intensity, recovery period.

Intervals on the VersaClimber are achieved by sprinting, that is, by increasing the speed and the stroke length of each step (faster rates of motion) or by exerting maximal forces against a preset rate of motion (slower rates of motion). Both of these methods of interval training condition the cardiovascular system to become used to extremely strenuous work loads.

AEROBIC INTERVAL TRAINING

Sprint intervals consist of short sprints (hydraulic control set to a minimum) of 5 - 15 seconds with both arms and legs pushing and pulling in the upward and downward directions (full body sets). Motion should be as quick as possible until the anaerobic threshold (not to exceed 85% of predicted maximal heart rate) is achieved. The foot straps should also be used for vertical lift. The upper torso should remain stable during the sprint interval to ensure unwasted motion. The interval should be followed by a recovery period of 2 - 3 minutes or until breathing is controlled and muscle fatigue has diminished. Repeat. As you become better conditioned, the rest time between each interval should become shorter.

Remember to always warm up 10 - 15 minutes on the VersaClimber before beginning interval workouts and to always stay within your target heart rate. It is also very important to always continue climbing during recovery periods at a slow, easy pace taking a 2 - 4 inch step. The following aerobic-anaerobic training chart is a general guideline for advanced interval training on the VersaClimber. This advanced training technique is not for beginners or for those who have health problems.

Time/Min	Exercise Description	% of Max HR
0 - 10 min	Warm Up To Aerobic Rate	Resting To 60-75%
10 - 20 min	Aerobic-Anaerobic Interval	
	Training Period:	
	Interval: Exert maximal power (Force and Speed) against a restricted rate of motion set by the hydraulic knob. Push and pull with both arms and legs for 8-12 strokes on each side through a full range of motion. Do not bottom out. Restricted rate of motion should be set to allow user to complete the 8-12 strokes and not exceed the upper percentages of maximal heart rate. After power strokes have been completed, relax and take a shorter, slower step until heart rate returns to lower aerobic recovery level. Start next interval. Complete as many as possible during the interval time limits.	
	Exercise Variations:	
	#1 Forehand Grip, Push and Pull Arms and Legs Aerobic Recovery - Short Slow Steps.	80 - 85% 60 - 65%
	#2 Stationary Hand Rails, Legs Only, Push and Pull Aerobic Recovery - Short Slow Steps.	80 - 85% 60 - 65%
	#3 Reverse Grip, Pull Down Arm, Pull Up Leg, Cross Body Aerobic Recovery - Short Slow Steps.	80 - 85% 60 - 65%
	#4 Forehand Grip Push Up Arm, Push Down Leg, Cross Body Aerobic Recovery - Short Slow Steps.	80 - 85% 60 - 65%
	#5 Forehand Grip, Push and Pull Arms and Legs Aerobic Recovery - Short Slow Steps.	80 - 85% 60 - 65%
	#6 Stationary Hand Rails, Legs Only, Push And Pull Aerobic Recovery - Short Slow Steps.	80 - 85% 60 - 65%
	#7 Reverse Grip, Pull Down Arm, Pull Up Leg, Aerobic Recovery - Short Slow Steps.	80 - 85% 60 - 65%
20 - 30 min.	#8 Forehand Grip, Push and Pull, Arms and Legs Aerobic Speed Work (Hydraulic Control Set To Minimum)	80 - 85% 60 - 65%
30 - 35 min.	Warm Down	70 - 75%

STRENGTH INTERVAL TRAINING

Strength intervals are achieved in a similar manner to aerobic interval training, except the intervals are performed at a slow rate of motion. First, turn the hydraulic control knob located at the bottom of the console in the clockwise direction, to approximately 75% of the user's capability. Begin climbing, exerting a maximum effort by pushing and pulling with arms and legs in the upward and downward direction for 5 to 10 seconds or until muscles are almost fatigued and anaerobic threshold is met (not to exceed 85% of your predicted maximal heart rate). Be sure to use the foot straps to maximize the vertical lift. Hands may be in the forward or reverse grip position depending on the desired muscle groups to be worked. Recover from the interval by setting the hydraulic control to a minimum (counter-clockwise direction) and taking short, slow, 2 to 4 inch strokes until breathing is controlled and muscles have recovered. As previously mentioned, as you become better conditioned, the rest period between each interval will become shorter.

1. Warm-up 10-15 minutes on the VersaClimber before beginning interval workouts.
2. Always stay within your target heart rate.
3. Continue climbing during the recovery periods.

USING THE VERSACLIMBER WITH MINOR INJURIES

MOST MINOR INJURIES THAT PREVENT RUNNING, DO NOT PREVENT CLIMBING

You must always use common sense when exercising. If you have an injury that hurts when you walk or run, it is common sense to stop walking or stop running. If the injury hurts while climbing, do it easier or do it slower. If it continues to hurt...stop! Consult with your doctor about any injury prior to engaging in an exercise program.

Some leg, knee, arm, chest, shoulder and back injuries can be safely exercised on the VersaClimber by limiting the range of motion or isolating the motion of the injured body part on one or both sides of the body. The smooth, rhythmic, impact free motion will decrease the likeliness of further assault to the injured limb while maintaining or increasing cardiovascular and muscular fitness.

The VersaClimber eliminates all pounding trauma and provides biofeedback information to the user to monitor step heights and step rates. It is ideal for controlled upper and lower body activity for fitness maintenance during the recovery phase of minor injuries.

LEG INJURIES

The VersaClimber eliminates pounding and jarring of the joints and can therefore be used to exercise such injuries as hamstring pulls, knee injuries, shin splints, achilles pulls, turf toe, leg bruises and sprains. By controlling the rate of climb, the range of motion, and/or by repositioning the foot or feet on the pedal(s), specific areas of the leg and foot may be exercised passively.

IMMOBILIZATION OF THE LOWER BODY

If the lower body must be completely immobilized due to injury, you can still strengthen your upper body and maintain cardiovascular fitness by doing an arms only workout on the VersaClimber. Stand on the base plate with one foot on each side of the post. Select or reposition the hand grips so that when one arm is outstretched it is fully extended. Alternate the pushing and pulling motion of the arms while the lower body remains still.

UPPER BODY INJURIES

The arms, chest and shoulders can be totally or partially immobilized while climbing by placing one or both hands on the stationary hand rails. If upper body limb motion is desirable without active muscle contraction, the injured arm can be placed on the moving hand grip and moved passively, without pushing or pulling.

BACK INJURIES

Exercise that causes back or neck discomfort is frequently the result of either vertical compression loading of the vertebrae or a shearing or bending of the spinal column and back muscles. By keeping the back straight while climbing, with the hydraulic control knob set to a minimum, the discomfort of the injury is minimized. The vertebrae are kept in line rather than being sheared, bent or compressed like with many other conventional exercises. To perform strength workouts, lift with the legs and pull with the arms. These forces tend to elongate the body and stretch the spinal column and provide an otherwise unattainable high level full body workout, without neck or back discomfort. If the lower back injury is such that it cannot be moved at all, you can still exercise the upper body by doing an upper body workout only. If the injury is in the cervical or thoracic areas, (lower or upper spine) one can utilize the VersaClimber by grasping onto the stationary hand rails and simply using the legs only.

SEATED EXERCISES

The seat provides an easy sit down routine for beginners and a safe exercise for those who require a non-weight bearing type of activity. Push and pull with any combination of healthy arms and legs to assist the movement of the injured limb or limbs. It is also possible to completely isolate one or both arms or one or both legs while in the non-weight bearing seated position. Set the hydraulic speed control and range of motion limiters to accommodate the injury. The heart rate control mode can also be used to regulate work intensity of the seated arm and leg exercise.

FOR ZERO RANGE OF MOTION IN KNEE

The VersaClimber can be used for aerobic and strength training by a person in a brace or a thigh to ankle weight bearing cast that can not bend at the knee. Workouts to maximal heart rates and maximal forces can be performed with one totally immobile leg while it may be necessary to walk up to and away from the machine using a crutch or cane.

To exercise, set the range of motion limiter on the same side as the injured leg, so the range of motion in the injured joint is limited. Place the injured leg on the lower foot pedal and keep it straight at all times. Do not bend at the hip, knee or ankle when mounting the VersaClimber. Step on the high foot pedal with the good leg and while holding the hand rails, move until both feet are at the same level. Lower the injured leg to the floor and the good leg will raise to the initial position. Repeat the motion allowing the injured leg to be moved just short of the stop, set to limit the range of motion of the injured leg. The good leg maintains a full range of motion. If the injured leg can be flexed at the knee, set the limiter to allow flexion to the extent that the injury will allow. This will gradually increase flexibility of the limb and work the local muscle groups.

FOR ZERO RANGE OF MOTION IN ANKLE

For shin splints, achilles tendon pulls, ankle sprains, turf toe and calf pulls, stand on the foot pedal with the heel of the injured foot contacting the pedal. Standing on the heel eliminates both flexion and muscular loading of the ankle, achilles and calf. By pulling with the arm on the injured leg side, further weight bearing loads can be removed from the injured leg. Stand on the foot pedal with the ball of the foot to accentuate ankle and calf muscle usage. Stand on the foot pedal with heel of the foot to accentuate the quad muscle usage.

UNPACKING INSTRUCTIONS

1. Remove the shipping container's top cover. Then remove the wooden cross support that holds the mainframe down and the two bolts securing the machine to the end of the wood crate. Using two people, carefully remove the vertical mainframe from the container and lay the machine on the floor. Avoid lifting or setting the machine on any portion of the black plastic housing or plastic oil accumulator (see page 26 for details).

- | | |
|--|---|
| <p>A. (1) Mainframe post with control module display attached</p> <p>B. (1) Pair of foot pedals</p> <p>C. (1) Pair of "Quick Release" handles</p> <p>D. (1) Base plate</p> <p>E. (1) Angle brace, 1 1/2" x 3" rectangular tubing</p> | <p>F. (1) Floor brace, 1/8" x 1 1/2" rectangular bar</p> <p>G. (2) Straight handrail supports, 1 1/2" diameter</p> <p>H. (2) S shaped padded side handrails</p> <p>I. (1) AC adapter</p> <p>J. (1) Hardware package</p> |
|--|---|

The following items are included in the single machine shipping crate:

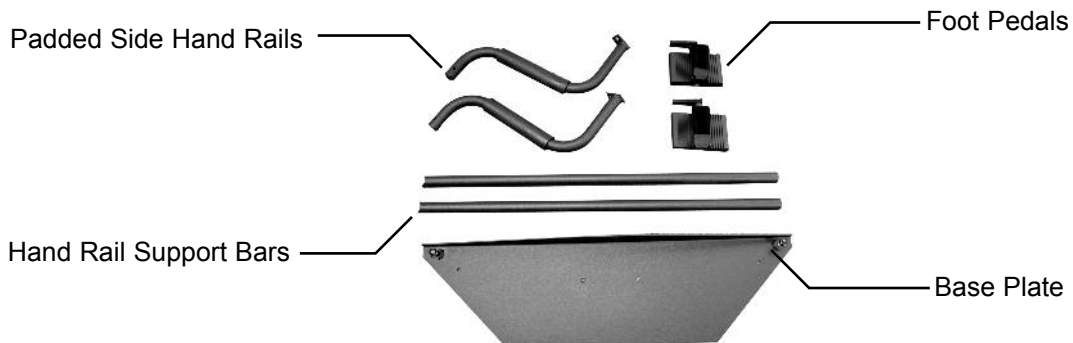
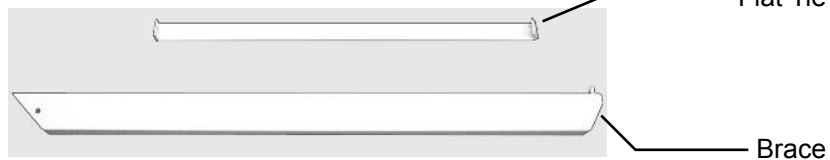

ASSEMBLY OF A VERSACLIMBER LX Series

NOTE:

Due to the durable, double welded, steel construction of the VersaClimber, two able bodied persons are required for its set up. The set up procedure requires two 9/16" wrenches and two crescent wrenches for pedals and side hand rails. Set up can be accomplished in about 15-20 minutes. When handling the machine, avoid lifting the machine by, or setting the machine on any part of the black housing or oil reservoir (accumulator).

TOOLS REQUIRED FOR ASSEMBLY:

(1) Phillips screwdriver

(2) 9/16" wrenches

(2) Crescent wrenches

(1) 1/4" hex key

(2) 3/16" hex key

Two able body persons are required for assembly.

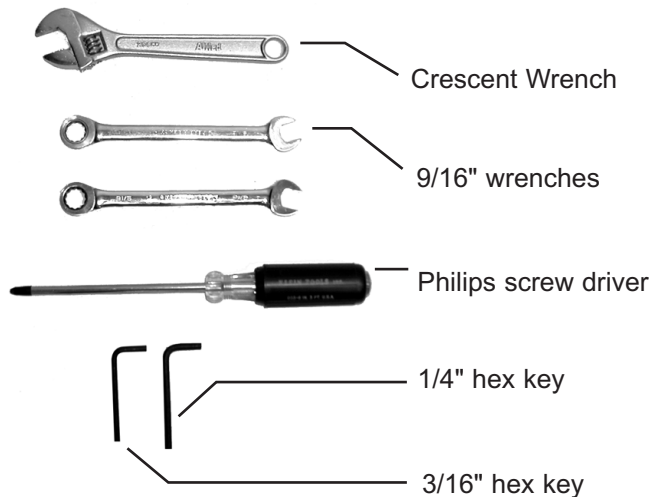

HARDWARE PACKAGE CONTENTS

- (1) 5/8" diameter x 4 1/4" hex head bolt and locking nut
- (2) 5/16" diameter x 2 1/2" round head screws
- (2) 3/8" - 16 x 1" hex head long bolts
- (1) 3/8" - 16 diameter x 1 3/4" hex head screw
- (7) 3/8" - self locking nuts
- (1) 1/4" hex key
- (1) 3/16" hex key
- 2) 5/16 - 18 x 1.5" Flat head bolt
- (2) 3/8 - 16 x 1" Flat head bolt
- (2) Washers





Use two people to remove mainframe from the shipping container.

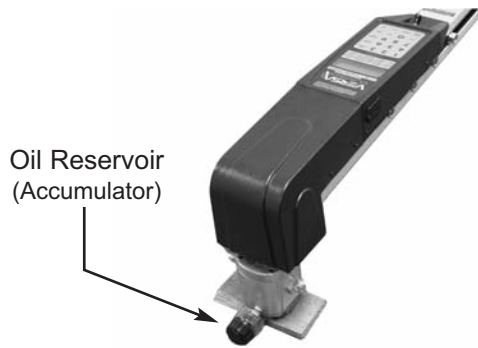

NOTE:
To protect the oil reservoir and the black plastic computer housing, rest the top end of the VersaClimber on a block of wood. ALX models this is not required.



Assemble the two piece support brace. Interlock flat tie to brace.



Bolt flat tie to brace using 3/8" self-locking nut.



Place base plate into position and attach to bottom of mainframe.



Tighten base plate to bottom of mainframe post.



Pre-Assemble the handrails. Bolt straight tube onto the "S" shaped padded side rails.

Bolt second straight hand rail tube to the left hand "S" shaped padded side rails. Use a black 5/16" x 2 1/2" round head bolt and tighten securely.



Attach pre-assembled hand rails to machine post and base plate using two crescent wrenches and a 3/16" allen wrench. Use the 5/8" x 4 1/4" long hex head bolt and lock nut to fasten the rails to the block welded on the back of the mainframe post. Tighten finger tight.



While supporting the upper portion of the rails, fasten lower part of rails to the base plate using 5/16" x 1 1/2" long flat head screws. Now tighten the 5/8" x 4 1/4" long bolt. Use the 5/16" x 1 1/2" long flathead socket screws to fasten the hand rails to the base plate. Tighten securely.



Using two crescent wrenches, fasten the upper part of rails to the block welded to the back of the machine

Install the handles as follows. The machine is supplied with one pair of quick release straight handles. To insert, depress the pin at the end of the handle. This "retracts" the locking balls at the other end of the handle. Insert the handle into any quick change adaptor and release pin. This extends the locking balls and secures the handle in place.

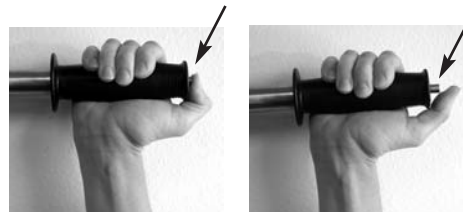

Install standard straight handles. To insert standard handle, depress pin with thumb and insert.



Running Handle. To insert running handle, depress pin with thumb and insert.



NOTE:

IT IS IMPORTANT TO TIGHTEN THE FOOT PEDALS SECURELY INTO POSITION. INJURY MAY RESULT AND DAMAGE TO THE MACHINE MAY OCCUR IF THEY ARE NOT PROPERLY FASTENED.



Bolt foot pedals on machine, with " L" pointing up, using two 3/8" x 1 1/4" long hex head bolts.

Tighten the 5/8" x 4 1/4" long bolts securely using the two crescent wrenches. The hand rails are now securely attached to each of the machine posts and the machine base plate.



Using two people lift VersaClimber to upright position.



With one person standing on the base plate, support mainframe the other person places the previously assembled support brace into position as shown above.

Next, attach the brace at the upper joint first using the 2 1/4" bolt, (2) washers and self-locking nut.

Attach the bottom joint of the support brace using the self locking nut.

Raise or lower the brace in the slot until the machine is stable "front to back", flush on the ground. Then fully tighten both nuts.



Tighten floor tie. Tighten locknut at bottom of angle brace.

The machine is now free to stand on its own.

TO LEVEL THE MACHINE FRONT TO BACK, LOOSEN THE 3/8" X 2 1/4" LONG BOLT. Position the base plate flat on the floor. Move the brace in the slot until the machine is stable front to back. Tighten the 2 1/4" long bolt.

Notes:

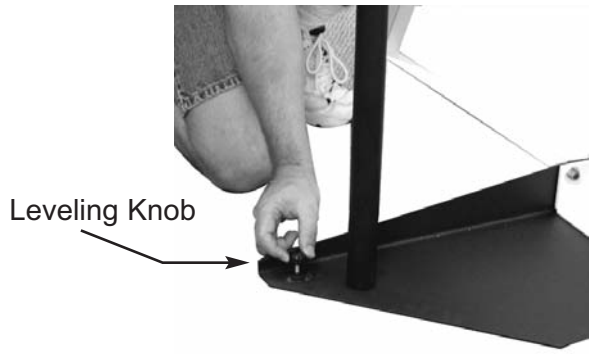

TO LEVEL MACHINE LEFT TO RIGHT, first level front to back. Then raise or lower the two adjusting knobs in the base plate until the machine is stable.

Install the AC adaptor by plugging the circular plugs into the appropriate receptacle at the top of each VersaClimber (LX models only), then plug it into any standard 120v wall outlet or extension cord.



HI-TRI AND HIGH FIVE ASSEMBLY INSTRUCTIONS

The following VersaClimber assembly instructions are to set up multi-station Hi-Tri (3 stations) and High-Five (five stations) configurations.

1. Follow the Unpacking and Assembly Instructions for single machines. In place of the base plate and two piece angled support bracket, you will receive a circular top plate or donut and 3 or 5 tubular floor ties and 3 or 5 base plates.

2. In place of the listed hardware, you will receive four 1" long bolts, two 1/1/4 long bolts, 8 self locking nuts and two flat head screws per climber.

3. Due to the heavy construction of the VersaClimber, two able bodied persons are required for its set up. the set up procedure requires two 9/16" wrenches, two crescent wrenches, 1/4" allen wrench, 3/16" allen wrench. Set up can be accomplished in about 30 minutes. In handling the machine, avoid lifting the machine by, or setting the machine on any portion of the black plastic housing, the hydraulic tubing or the hydraulic reservoir. The hydraulic pump can be used as a support or as a hand lift point.

4. Place the multi-machine base plates into position on each of the climbers. Attach each base plate to the mainframe of each climber with two flat head screws through the bottom. Tighten securely using an allen key and 9/16" wrench.

5. Pre-assemble hand rails. Bolt one straight hand rail tube to the right hand angled "S" shaped tube. Use a 5/16" x 21/2" round head bolt and tighten securely.

6. Bolt the second straight hand rail tube to the left hand angled "S" shaped tube. Use a 5/16" x 21/2" round head bolt and tighten securely.

7. Assemble rails to machine post and base plate. Use the 5/8" x 41/4" long hex head bolt and lock nut to fasten rails to the block welded on the back of each machine. Tighten, finger-tight.

8. Use the 5/8" x 11/2" long flat head socket screws to fasten the hand rails to the base plates. Tighten securely.

9. Tighten the 5/8" x 41/4" long bolts securely using the two crescent wrenches.

10. The hand rails are now securely attached to each of the machine posts and the machine base plates.

11. Attach the first VersaClimber to the circular top plate using four 1" bolts and four self locking nuts. Angle brackets must set on top of circular plate. Bolts go through from bottom, nuts on top. Nuts must be snug but not fully tightened.

12. Install second Versaclimber to top plate in similar fashion. Do not fully tighten nuts.

13. Lift assembly of two Versaclimbers, place third VersaClimber into position and loosely tighten bolts through circular plate.

14. The High-Five multi-station will require the attachment of two additional VersaClimbers to the top plate.

15. Using the 11/4" bolts and self locking nuts, connect the bases of the Versa Climbers together with the tubular floor ties. The ties overlap so that each tie is held by two bolts at each VersaClimber with nuts on the back side. Do not fully tighten until all ties are in place.

16. After all ties are in place, tighten bottom tie nuts and bolts completely, (two per VersaClimber).

17. After bottom tie bolts are fully tightened, proceed to tighten all top plate nuts and bolts.

18. Install the foot pedals by making sure the "L" of the pedal is pointed up. Use two 3/8" - 16 x 11/4" hex head bolts provided to mount each pedal. Bolt screws into the hole pattern that is located 2 1/4" and 4 1/4" from the bottom of each internal slide bar (carriage). Tighten securely. The pedals are interchangeable.

NOTE:

IT IS IMPORTANT TO TIGHTEN THE FOOT PEDALS SECURELY INTO POSITION. INJURY MAY RESULT AND DAMAGE TO THE MACHINE MAY OCCUR IF THEY ARE NOT PROPERLY FASTENED.

19. Install the handles as follows. The machine is supplied with one pair of quick change handles. To insert, depress the pin at the end of the handle. This "retracts" the locking balls at the other end of the handle. Insert the handle into any quick change adaptor and release the pin. This extends the locking balls and secures the handle in place.

20. Install the AC adaptor by plugging the circular plugs into the appropriate receptacle at the top of each Versaclimber (LX models only), then plug it into any standard 120v wall outlet or extension cord.



MAINTENANCE INSTRUCTIONS

MECHANICAL DESCRIPTION - The VersaClimber consists of a mainframe made of two rectangular tubes that are welded together. The mainframe is supported by a base plate and bracket that are bolted to it. A shaft and sprocket is located at the top of the mainframe. The shaft ends are supported with ball bearings. One end of the shaft is coupled to a digital shaft encoder that is used to transmit climb rate and distance data to the micro-computer.

Two rectangular bars that carry the handle grips and foot pedals are located inside the two rectangular tubes. These bars also carry rollers and slide bearings. They are attached to a roller chain that passes over the top and bottom sprockets and connect the bars together. While the VersaClimber is in use, the bars travel vertically up and down inside the rectangular tubing whenever the person climbing exerts sufficient upward or downward forces on the foot pedals or handles. There are rubber shock mounts located under the foot pedal shafts to absorb any shock if the twenty-inch stroke is exceeded. The digital encoder and micro-computer electronics are enclosed in a black plastic housing mounted on the upper portion of the machine.

THE HYDRAULIC SYSTEM

The hydraulic system consists of a heavy duty, reversible gear pump. A flow control valve is connected between the input and the output ports with copper tubing and heavy duty high pressure tube fittings. A clear oil fill reservoir is located on top of the pump, at the very top of the unit.

NOTE: The oil in the pump reservoir always darkens in color and most of the time, turns black in color. This is normal.

The hydraulic resistance is developed in a permanent closed loop system filled with

hydraulic oil that does not require changing. The oil is maintained in the system with one static seal and one rotating shaft seal. The rotating shaft seal is rated for continuous duty at operational pressures. If a large amount of slack (more than 1/2" travel) develops when reversing the stepping motion, this indicates a possible loss of oil from the system. Visually check the fittings and the shaft seal for oil leaks. Tighten any leaking fitting and then fill the reservoir with oil up to 1/2" from the top.

ROLLER AND SLIDE BEARINGS

There are rollers and slide bearings made from high pressure application moly-disulfide filled nylon on each oscillating bar. The roller bearings are held on with 3/8" shafts and press-on grip rings. The slide bearings are held in place with two 3/8" pins. The slide bearings have lubrication points. This bearing material is expected to be maintenance free for years. The bearings are lightly lubricated at the factory and the wear life and smooth operation of the machine can be assured by lubricating every two months or sooner if required. Lubricate with 3-In-One High Performance Spray Lubricant with PTFE.

NOTE: NEVER LUBE INTERNAL TRACKS WITH ANY KIND OF GREASE.

You can find 3-In-One High Performance Spray Lubricant with PTFE at Graingers Industrial Supply www.grainger.com or www.wd40.com (Item #10046). If not call our service department 1-800-237-2271 ext. 226.

First wipe any excess oil, lint, dirt, etc. from all internal accessible surfaces of the rectangular tubing. Move the bars up and down to allow access to clean the two foot pedal slots and the two hand grip slots. Use paint thinner to remove the oil and lint residue. When clean, wipe or spray a synthetic lubricant on all four internal surfaces of the rectangular tubing.

PREVENTATIVE MAINTENANCE SCHEDULE

Daily:

1) Wipe down the main post, base and side rails with a rag and non-solvent, non-ammonia cleaning solution.

Weekly:

1) Hand check quick-release handle bushings, which the handles lock into, on both sides to make sure they are tight.

2) Check oil level in top reservoir, it should be at least 3/4 full when it leave the factory and should never drop. (Excludes ALX model)

A) If oil level is low, fill using medium wt. hydraulic oil. Oil level should remain 3/4 full.

B) If you notice the oil has turned dark or black, this is normal. Oil never has to be changed.

Monthly:

1) Check bottom chain tightness; with the pedals even you should be able to push the chain in about 1/4 inch. If the chain pushes in more than this, then the chain is loose and will need to be tightened. See below.

*To tighten the chain you will need a 9/16" open end wrench. From behind the machine, go to the bottom of the main post and there will be an opening just above where the main post connects to the straight base. In the opening you will find a 9/16" hex head bolt. Loosen the bottom bolt first, then loosen the top bolt until the idler is movable. With a screwdriver, push down gently on the flat spacer under the bolt heads until the slack is taken out of the chains. Then, while maintaining chain tension, tighten the top bolt first, then tighten the bottom bolt.

2) Spray internal tracks with 3-In-One Synthetic Lubricant with PTFE to maintain a smooth running fluid motion.

3) Check to make sure the pedals are spinning freely, if not spray pedal shafts with 3-In-One Synthetic Lubricant with PTFE.

Quarterly:

1) Wipe off the top & bottom chains and put a very light coat of light grease on chain.



Using a toothbrush, or firm paint brush this is the ONLY place you will use grease on the VersaClimber.

NOTE: Never lube the internal tracks with any kind of grease.

CHAIN TENSION AND LUBRICATION

The chain tension control is located at the base of the machine.

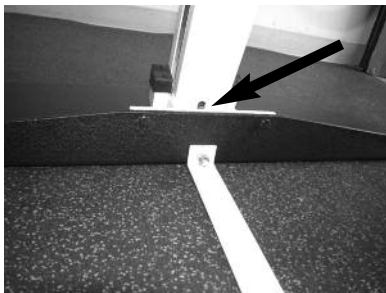

It is set / adjusted at the factory to remove slack in the lower chain. During the first few weeks of operation, the chain and sprockets will settle in and may produce a slight amount of slack in the lower roller chain.

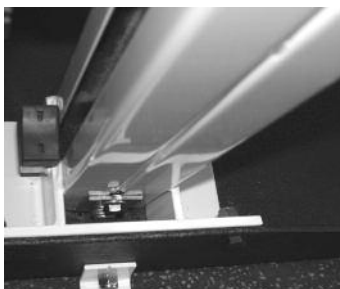

If this occurs, place the two foot pedals at equal height and loosen the two bolts located down in the slot at the back base of the machine. Use a 9/16" open end wrench.



Loosen the bottom bolt first, then loosen the top bolt or about 3/4 of a turn just enough for the idler bracket is slightly movable.



With a screwdriver, push down gently on the flat spacer under the bolt heads until the slack is taken out of the chains.



Then, while maintaining pressure on the chain tension, tighten the top bolt first, then tighten the bottom bolt.

Every three months, lubricate the upper and lower sprockets and upper and lower chain. Use light grease.



With the aid of a flashlight and a 4 inch oil spout can, place a few drops of oil between the bottom sprocket hub and its mounting bracket. Wipe off excess oil from the sprocket and both chains. Lubricant may be purchased directly from VersaClimber's Service Department by calling 1-800-237-2271 x226

OTHER MAINTENANCE

CLEANLINESS -- It is recommended that the VersaClimber be placed on approximately a five foot square rubber or plastic mat because users are going to perspire profusely. To prevent corrosion, it is recommended that the machine mainframe and base plate be wiped clean with soap and water at a "good housekeeping frequency" to remove salts and other body residues. Wipe machine down no less than once a week. It is further recommended that the machine be cleaned and waxed once a month with any good quality car wax.

HANDGRIPS -- The handgrips are a high quality 1 1/4" diameter rubber bicycle grip. When handle grips wear out replace them with any good quality "flanged" grip from your local bike shop or contact HRI for spares.

FOOT PEDALS -- The foot pedals are made

of a strong durable extruded aluminum. Every two months place a few drops of light oil between the pedal and pedal shaft at both ends of the foot pedal.

If a malfunction occurs, refer to trouble shooting guide or contact the Heart Rate Inc. Service Department for further instructions.

To remove the electronic control unit from a single machine installation unit, simply remove the four mounting screws on the sides of the plastic console.



Then unplug the wires to the digital encoder and from the power supply. Replacement is the reverse of this procedure. If the unit is to be shipped, package it carefully to avoid physical damage.

The machine can be used while the electronics are either turned off or out for repair if the bare wire ends are insulated with electrical tape.

TROUBLE SHOOTING

If a malfunction occurs, please refer to the following symptom guide for instruction.

TO EXPEDITE SERVICE, CALL THE FACTORY FIRST. RETURN ALL PARTS TO THE FACTORY WITH A BRIEF NOTE STATING THE FACILITY NAME, ADDRESS, PHONE NUMBER, CONTACT NAME AND A DESCRIPTION OF THE SYMPTOM. IF A DESCRIPTION OF THE PROBLEM IS NOT INCLUDED WITH THE RETURNED PART, REPAIRS MAY BE SIGNIFICANTLY DELAYED. Please call Parts & Service 1.800.237.2271 x226

SYMPTOM--ALL ZEROS ARE REGISTERING ON MODULE.

If all zeros register on the display when the machine is in motion, the computer is not receiving input data from the upper rotating shaft. The problem could be a faulty encoder circuit board, broken or loose wire connectors between the encoder circuit board and computer or the encoder disk has become detached from the pump shaft.

With the top black plastic cover removed, slowly move the handles up and down. A plastic encoder disc should be seen rotating through a slot that houses infra red sensors. Check to be sure that the disc and sensor are clean and the encoder circuit board and the module are in tact. If no mechanical malfunction is visible, the encoder circuit board may be faulty and should be replaced. If necessary, contact Heart Rate, Inc. for further information.

SYMPTOM--LCD READOUT HAS A BLACK SPLOTCH

If the display window is ruptured, the LCD glass is also ruptured and a black shadow area will appear in the LCD. The module will need to be removed and returned to Heart Rate, Inc. for LCD replacement and repair. To remove the module, remove the four screws that mount the module to the machine and disconnect the wires from the module. The machine can be used while the module is out for repair.

SYMPTOM--MACHINE SQUEAK.

A lack of lubrication can cause a squeak in the bottom sprocket shaft, or the foot pedal shaft. To lubricate the bottom sprocket. If rotating the foot pedal while standing on the pedal causes a squeak, lubricate the shaft/pedal interface. Remove the snap ring from the end of the pedal shaft with snap ring pliers being careful not to over extend the ring. Remove the foot pedal and degrease the shaft and pedal hole. If necessary, use fine sandpaper to smooth the shaft surface. Apply grease liberally and reassemble the pedal. Be sure that the snap ring is fully

engaged in the groove.

SYMPTOM--MACHINE IS "STICKY" IRREGULAR OR HARD TO MOVE.

The foot pedals and handgrips are attached to metal bars that move up and down inside C shaped metal channels. The bars have plastic rollers and slides that guide the bars through the channels. Over time, the lubricant in the channels picks up dust and lint and dries out producing a "sludge" tar like coating that prevents smooth machine operation. If the tar like coating is removed the machine will function like brand new.

SYMPTOM--OIL ON BASE PLATE

Occasionally excess lubrication may be applied at the factory and run down the inside of the post onto the base plate. Do not be concerned, all parts are functioning normally. Wipe up the excess oil with a rag.

SYMPTOM-- OIL LEAK FROM HYDRAULIC ADJUSTMENT KNOB

An oil leak from the hydraulic knob indicates a malfunction in the needle valve. The needle valve must be replaced. Do not remove the defective valve until you receive the new one. Installation instructions will be sent from the factory with your replacement valve.

SYMPTOM-- OIL LEAK FROM RESERVOIR ON HYDRAULIC MOTOR

If oil leaks from the top seal between the black plastic cap and the plastic bowl, tighten cap by hand. If oil leaks from the threads at the base of the accumulator, tighten by turning clockwise with an open-end wrench. If reservoir is physically damaged and a replacement is required, do not remove the reservoir until you receive a new one. The replacement will include installation instructions.

VERSACLIMBER SPECIFICATIONS

PHYSICAL SIZE

Height, Model CL-108LX	7 feet, 10 inches
Height, Model CL-109LX	8 feet, 10 inches
Required Floor Space	48 inches x 48 inches
Weight	130lbs. - 150 lbs - Assembled

PHYSICAL CHARACTERISTICS

Structural	Steel
Sliding and Rolling Bearings	Filled Nylon
Speed Control/Force Control	Hydraulic
Data Processing	8 Bit Microcomputer
Data Display	22 Digit LCD
110 VAC Powered	12 Volt AC Adapter
Quick Change Hand Grips	2
Stationary Hand Rails	2
Hand Grip Adjustment	3.75 Inch Increments
Foot Pedals	2

FUNCTIONAL FEATURES

Pedal/Step/Climb Stroke Length	0 To 20 Inches
Overall Climb Rate	Ability Of Person Climbing
Hydraulic Climb Rate Control	20-240 Feet/Min.
Hydraulic Force Control	0 To 500 Lbs.
Program Workout Levels	1 To 15
Heart Rate Control	120 To 190
Climb Angle	75 Degrees
Vertical Lift Factor	96.6 Percent

VERSACLIMBER ACCOMMODATIONS

Level of Physical Fitness	Sedentary To Elite Athlete
Climber's Height	4 Feet 6 Inches And Taller
Climber's Weight	50 To 350 Pounds
Age and Sex	Any

MICROCOMPUTER FUNCTIONS

Exercise Time	0 To 99.9 Minutes
Exercise Rate	0 To 350 Feet/Min.
Total Exercise Distance	0 To 9999 Feet
Total Exercise Steps	0 To 9999 Feet
Step Height/Stroke Length	0 To 20 Inches

SPARE PARTS LIST

In the event that a replacement part is ordered from the factory, Please refer to the following spare parts list for the correct part description and part number. This information will expedite your shipment when calling our Service Department.

LX Module (108/109) LX.....	158-01-000
LX Module (108A/109A) LX.....	161-01-000
LXP Module (1081109) LXP.....	166-02-000
LXP Module (108A/109A) LXP.....	166-03-000
Encoder Circuit Board Assembly.....	013-01-000G
Encoder Disc.....	013-01-003
Electrodes.....	041-00-000
LCD/VersaClimber	54502
Accumulator.....	30038
Valve Stem.....	30027
Foot Pedal Assembly.....	101-04-000
Foot Pedal Straps.....	008-03-000
Foot Pedal Connector, (Plastic Triangle).....	008-00-007
Quick Change Handle (1).....	101-06-000
Quick Change Running Handle (1)	101-03-000
Handle Grip Only.....	30009
8' Bar - Left.....	055-00-000
8' Bar - Right.....	054-00-000
Slides.....	003-00-009
Rollers.....	003-00-005
CL-108 Pump Assembly.....	039-00-000
AC Adaptor.....	60019
AC Adaptor Assembly - Hi-Tri.....	114-00-000
AC Adaptor Assembly - Hi-Five.....	115-00-000
Brackets - HI-Tri Assembly (108).....	048-00-000
Brackets - High Five Assembly (108).....	050-00-000
Base Plate.....	101-00-001
Brace.....	101-00-003
Tie.....	101-00-002
Rail Assembly (no base plate).....	047-02-000
Station Base Plate.....	047-00-008
8' Top Cover.....	029-00-000
Bottom Chain Assembly.....	037-00-000
Top Chain Assembly.....	043-00-000
Pump Sprocket.....	30010
Sprocket Assembly (CL-108A/CL-109A).....	042-00-000
Pump Sprocket Bushing (Post 1990).....	30065
Seat.....	019-02-000
Ears - Left.....	147-00-005
Ears - Right.....	147-00-004
Leg Isolator.....	145-01-000

Stopper.....	101-00-008
Flange (108ALX/109ALX) (2 each).....	30033
Bearing (108ALX/109ALX) (1 each).....	30044
Super Lube.....	30090
Top Chain Master Link.....	30003
Bottom Chain Master Link.....	30007
Front Strip.....	60039
Bottom Sproket Assembly.....	002-00-000
A/C Jack Assembly.....	045-00-000
Small Brass Elbow.....	B-500-2-2 30026
Large Brass Elbow.....	B-500-2-4 30014

For Parts & Service Please call: 1.800.237.2271 x226

VERSACLIMBER THREE YEAR LIMITED WARRANTY

1. Heart Rate, Inc. (H.R.I.) warrants to the original purchaser that Institutional VersaClimbers are free from defects in material and workmanship under normal use and maintenance under a three year limited warranty subject to the terms and conditions Hereafter set forth. Except for the above warranty, it is expressly agreed that NO WARRANTY OF MERCHANTABILITY OR FITNESS FOR A PARTICULAR PURPOSE or of a particular use nor any warranty of any kind whatsoever express, implied or statutory is made by H.R.I.

2. This warranty does not cover any damage caused by misuse, tampering, negligence, accidents, abnormal conditions, lack of adequate maintenance or unauthorized service or alterations to the product.

3. Liability of H.R.I. is limited to either repair or replacement of the defective part or the replacement of the machine at the option of H.R.I. on an exchange basis, with the customer bearing all costs of shipping and handling to and from the factory.

4. Length of Warranty, Parts

<u>ITEM</u>	<u>PARTS REPLACEMENT</u>
FRAME, HAND RAILS, BASE PLATE	3 YEARS
HYDRAULIC MOTOR	3 YEARS
FOOT PEDALS	2 YEARS
HANDLES	2 YEARS
CHAINS AND SPROCKETS	2 YEARS
DISPLAY ELECTRONICS	2 YEARS
ROLLERS AND SLIDES	2 YEARS
ELECTRONICS	1 YEAR
HAND GRIPS	1 YEAR
FOOT PEDAL STRAPS	1 YEAR
SEAT	1 YEAR

5. Length of Warranty, labor

During the first year, all labor is covered by the warranty. All labor repairs will be performed at the factory on warranty and non-warranty parts.

6. This warranty does not cover paint deterioration, discoloration, chipping or rust.

7. After all of the foregoing conditions have been complied with, if H.R.I. shall thereupon attempt repairs and /or replacements which shall for any reason fail, H.R.I.'s shall be allowed to continue to attempt to remedy any defects for so long a period of time as, In H.R.I. sole judgement, such attempt is justified.

8. The foregoing shall be buyer's sole and exclusive remedy, whether based on or otherwise, and H.R.I. shall not be liable for any injuries to persons or property. In no event shall H.R.I. be liable for incidental or consequential damages to commercial losses, nor for any other loss or damages except as above set forth.

9. This warranty is expressly in lieu of all other warranties, express or implied, and of all other obligations or liability on the part of H.R.I. No person, firm or corporation is authorized to assume any other liability on behalf of H.R.I.

VERSACLIMBER WARRANTY VALIDATION FORM

To validate your Warranty Registration, please fill out the following form and return it to Heart Rate, Inc.

VersaClimber Model Number: _____

Machine Serial Number: _____

Name: _____ Title: _____

Facility Name: _____

Address: _____

City: _____ State: _____ Zip: _____

Phone Number: (____) _____ (____) _____

Email: _____ Fax: (____) _____

Purchase Date: _____ From HRI [] Dealer [] Other []

Dealer Address: _____

City _____ State _____ Zip _____

I first saw/heard about the VersaClimber: _____

I have seen the VersaClimber advertisements in the following magazines: _____



A trusted name in fitness for nearly 30 years. Proudly made in USA since 1981.

To learn more about other great VersaClimber accessories and options to enhance your workout, please visit us on line at www.versaclimber.com or call our toll free number at 1.800.237.2271 for more details.

